

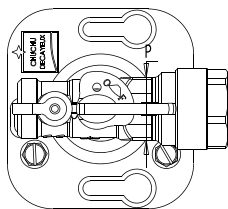

ROBINET DE SÉCURITÉ 1/4 DE TOUR POUR PE À JSC AVEC SOCLE DE FIXATION

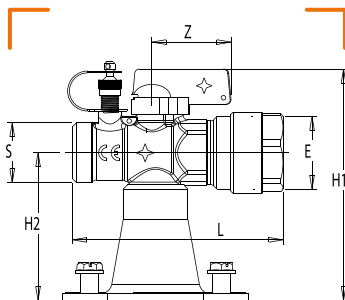





CARACTÉRISTIQUES TECHNIQUES

Normes : NF EN 331 / NF EN 1555-3+A1

Température : -20°C à +60°C

Divers : Pour les références avec prise de pression: modèles réservés aux distributeurs gaz en coffrets et blocs de détente élévation et enterrés

CALIBRE	ENTRÉE PE (E)	SORTIE MÂLE (S)	PRISE DE PRESSION	L	P	H1	H2	Z	NF	CE	RÉF
15	PE Ø 20	JSC 3/4"	x	94	28	102	65	35		x	8915-094
15	PE Ø 20	JSC 3/4"		94	28	102	65	35		x	8915-294
25/15	PE Ø 32	JSC 3/4"	x	102	28	102	65	35		x	8915-032
25/15	PE Ø 32	JSC 3/4"		102	28	102	65	35		x	8915-232
25	PE Ø 32	JSC 1"1/4	x	120	39	106	65	35		x	8925-095
25	PE Ø 32	JSC 1"1/4		120	39	106	65	35		x	8925-295
32/25	PE Ø 40	JSC 1"1/4	x	125	39	106	65	35		x	8225-000
32	PE Ø 40	JSC 1"1/2	x	142	55	127	65	56		x	8932-096