

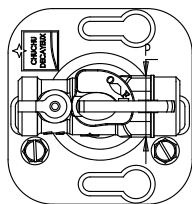

ROBINET DE SÉCURITÉ 1/4 DE TOUR DOUBLE MÂLE JSC AVEC SOCLE DE FIXATION

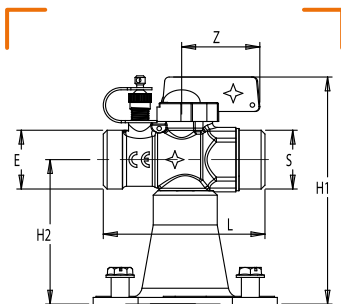







CARACTÉRISTIQUES TECHNIQUES

Normes : NF E 29-141 / NF EN 331

Température : -20°C à +60°C

Divers : Pour les références avec prise de pression: modèles réservés aux distributeurs gaz en coffrets et blocs de détente élévation et enterrés

CALIBRE	ENTRÉE MÂLE (E)	SORTIE MÂLE (S)	PRISE DE PRESSION	L	P	H1	H2	Z	NF	CE	RÉF
15	JSC 3/4"	JSC 3/4"	x	72	28	102	65	35		x	8915-018
15	JSC 3/4"	JSC 3/4"		72	28	102	65	35		x	8915-088
25	JSC 1"1/4	JSC 1"1/4	x	110	39	106	65	35		x	8925-019
25	JSC 1"1/4	JSC 1"1/4		110	39	106	65	35		x	8925-089
32	JSC 1"1/2	JSC 1"1/2	x	130	55	127	65	56		x	8932-020
32	JSC 1"1/2	JSC 1"1/2		130	55	127	65	56		x	8932-090